

Installation guide

Electronic superheat controller

Type EKE 1C

English



More info

Introduction

Superheat controller EKE 1C is for use where superheat must be accurately controlled, typically in commercial air conditioning, heat pumps, commercial refrigeration, food retailing and industrial applications.

Compatible valves: Danfoss ETS 6 / ETS / ETS Colibri®, KVS / KVS Colibri® and CCM / CCMT / CTR valves.

Reference: For details please see EKE data sheet.

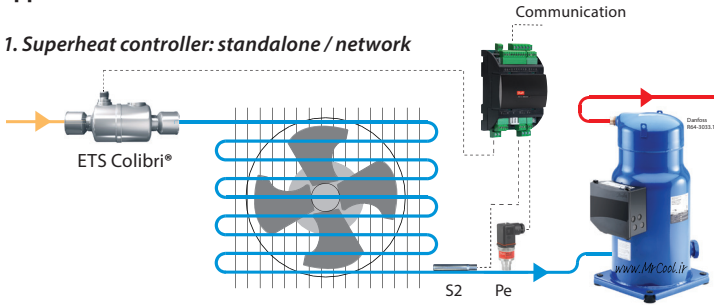
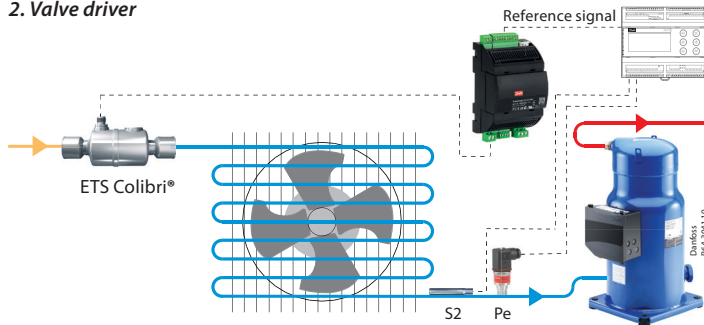
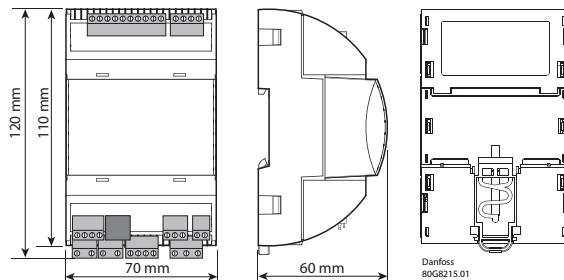
Applications
1. Superheat controller: standalone / network

2. Valve driver

Dimensions EKE 1C

Weight: 190 gram

TECHNICAL SPECIFICATIONS

POWER SUPPLY

EKE has galvanic isolation by switch-mode power supply.

24 V AC \pm 20 %, 50/60 Hz. Maximum power consumption: 18 VA.

Input voltage rating (DC): 24 V DC \pm 20%, 15 W.

I/O	TYPE	NUMBER	SPECIFICATION
Analog inputs			Max. 15 V input voltage Do not connect voltage sources to unpowered units without limiting the current to analog inputs (overall 80 mA). Open circuit HW diagnostics available for voltage input on : A13 and A14
	Voltage	2	A13, A14 0 - 5 V, 0 - 5 V ratiometric, 0 - 10 V
	Current		A13, A14 0 - 20 mA
	NTC	3	A11 (S3/S4), A12 (S2), A15 (S3/S4) NTC temperature probes, 10 k Ω at 25 °C
	Pt 1000		A11 (S3/S4), A12 (S2) Accuracy: \leq 0.5 K Resolution: 0.1 K. Range: 723 Ω to 1684 Ω
Auxiliary Supplies	1	5 V + Sensor supply: 5 VDC / 50 mA, overload protection approximately 150 mA	
	1	15 V + Sensor supply: 15 VDC / 30 mA, overload protection approximately 200 mA	
Digital inputs	Voltage free contacts	2	DI1, DI2 Steady current minimum 1mA Cleaning current 100mA at 15 V DC On: RIL \leq 300 Ω Off: RIH \geq 3.5 k Ω
Digital output	Relay	1	C1-NO1 Normally Open: 3 A General purpose, 250 V AC, 100 k cycle Normally Open: 3 A Inductive (AC-15), 250 V AC, 100 k cycle Normally Closed: 2 A General purpose, 250 V AC, 100 k cycle
Stepper motor	Bipolar / unipolar	1	Stepper valves: A1, A2, A3, A4 Bipolar and unipolar stepper motor output: - Danfoss ETS / KVS / ETS C / KVS C / CCMT 2 – CCMT 42 / CTR Valves (green, red, black, white) - ETS6 / CCMT 0 / CCMT 1 (black, red, yellow, orange) Other Valves: - speed 10 – 400 pps - drive mode 1/8 microstep - max. peak phase current: 1.2 A (848 mA RMS) - max. drive voltage 40 V - max. output power 12 W
Battery backup		1	VBATT: 18 – 24 V DC (24 V DC recommended): - max. battery current: 850 mA at 18 V - battery alarm will be activated below 16 V DC and above 27 V DC
Communication	RS-485 RTU	1	RS485 Galvanic isolation. No Built-in termination.
	CAN	1	CAN - RJ RJ connector to directly connect and supply a MMI.

GENERAL FEATURES AND WARNINGS

PLASTIC HOUSING FEATURES

- DIN rail mounting complying with EN 50022
- Self-extinguishing V0 according to IEC 60695-11-10 and glowing/hot wire test at 960 °C according to IEC 60695-2-12
- Ball test: 125 °C according to IEC 60730-1. Leakage current: \geq 250 V according to IEC 60112

OTHER FEATURES

- Operating conditions CE: -20T60, 90% RH non-condensing
- Storage conditions: -30T80, 90% RH non-condensing
- To be integrated in Class I and/or II appliances
- Index of protection: IP 20 on product and IP40 only on the front cover
- Period of electric stress across insulating parts: long
- Suitable for using in a normal pollution environment
- Category of resistance to heat and fire: D
- Immunity against voltage surges: category II
- Software class and structure: class A

CE COMPLIANCE

This product is designed to comply with the following EU standards:

- Low voltage guideline: 2014/35/EU
- Electromagnetic compatibility EMC: 2014/30/EU and with the following norms:
 - EN61000-6-1, EN61000-6-3 (immunity for residential, commercial and light-industrial environments)
 - EN61000-6-2, EN61000-6-4 (immunity and emission standard for industrial environments)
 - EN60730 (Automatic electrical controls for household and similar use)

GENERAL WARNINGS

- Every use that is not described in this manual is considered incorrect and is not authorized by the manufacturer
- Verify that the installation and operating conditions of the device respect those specified in the manual, especially concerning the supply voltage and environmental conditions
- This device contains live electrical components. All service and maintenance operations must therefore be performed by qualified personnel
- The device must not be used as a safety device
- Liability for injury or damage caused by the incorrect use of the device lies solely with the user

INSTALLATION WARNINGS

- Recommended mounting position: vertical
- Installation must comply with local standards and legislation
- Before working on the electrical connections, disconnect the device from the main power supply
- Before carrying out any maintenance operations on the device, disconnect all electrical connections
- For safety reasons the appliance must be fitted inside an electrical panel with no live parts accessible
- Do not expose the device to continuous water sprays or to a relative humidity greater than 90%.
- Avoid exposure to corrosive or pollutant gases, natural elements, environments where explosives or mixes of flammable gases are present, dust, strong vibrations or shock, large and rapid fluctuations in ambient temperature that might cause condensation in combination with high humidity, strong magnetic and/or radio interference (e.g. transmitting antennae)
- When connecting loads be aware of the maximum current for each relay and connector
- Use cable ends suitable for the corresponding connectors. After tightening connector screws, tug the cables gently to check their tightness
- Use appropriate data communication cables. Refer to the EKE data sheet for the kind of cable to be used and setup recommendations
- Minimize the length of probe and digital input cables as much as possible, and avoid spiral routes around power devices. Separate from inductive loads and power cables to avoid possible electromagnetic noises
- Avoid touching or nearly touching the electronic components fitted on the board to avoid electrostatic discharges

PRODUCT WARNINGS

- Use a class II category transformer for 24 V AC power supply.
- Connecting any EKE inputs to mains voltage will permanently damage the controller.
- Battery Backup terminals does not generate power to recharge a device connected.
- Battery backup - the voltage will close the stepper motor valves if the controller loses its supply voltage.
- Do not connect an external power supply to the digital input DI terminals to avoid damaging the controller.



DIN rail mounting / demounting

The unit can be mounted onto a 35 mm DIN rail simply by snapping it into place and securing it with a stopper to prevent sliding. It is demounted by gently pulling the stirrup located in the base of the housing.

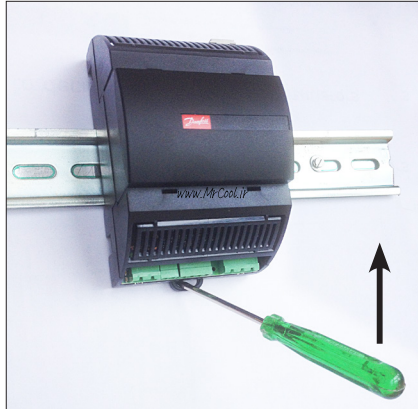
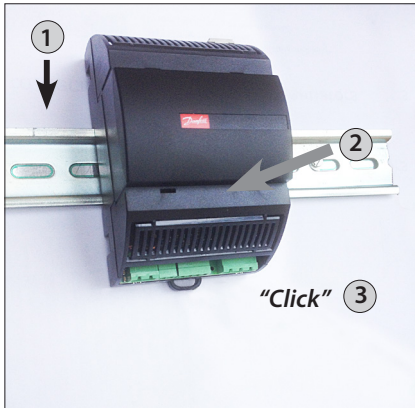

Connection overview: EKE 1C

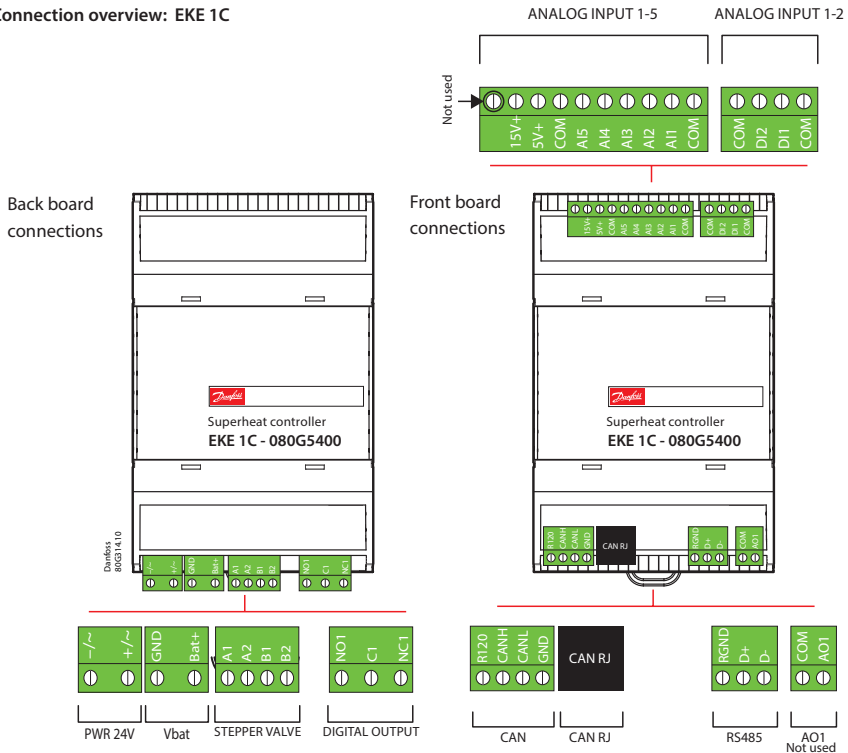

EKE 1C - Front board connection overview

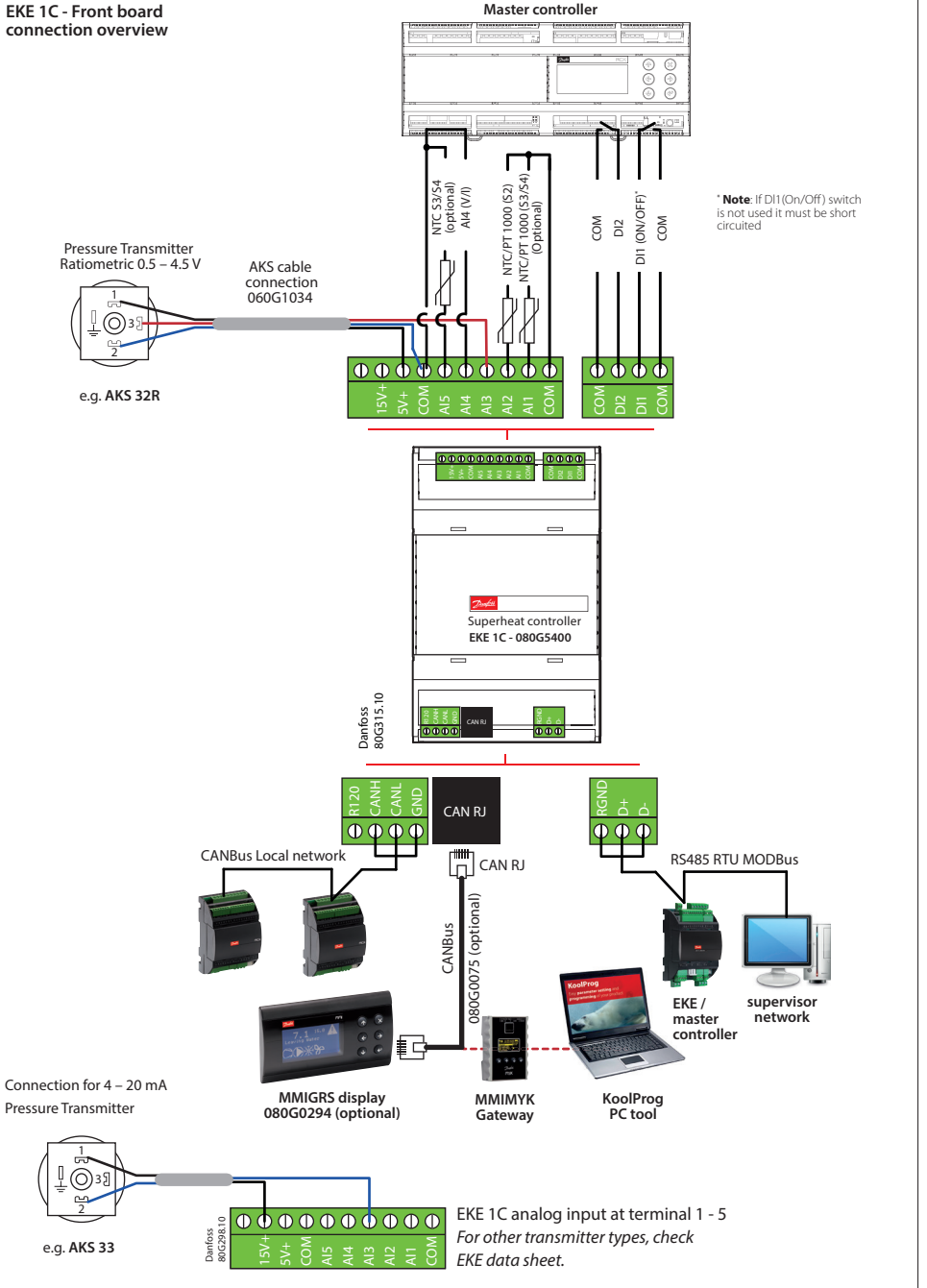

EKE 1C - Back board connection overview

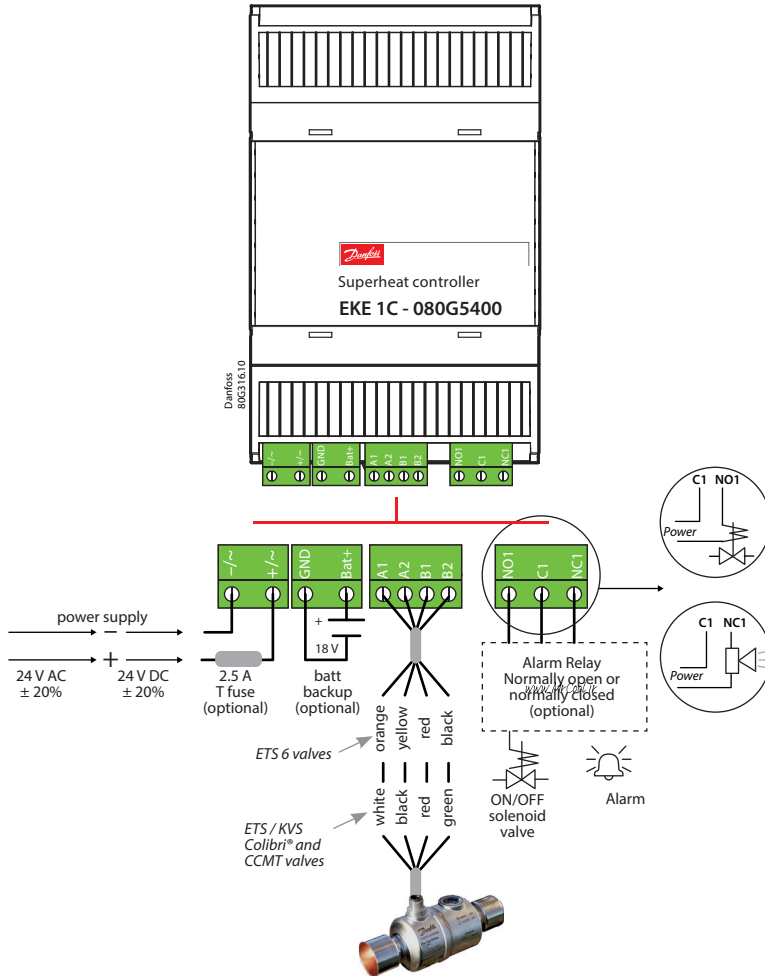

Sensor mounting: Temperature sensor

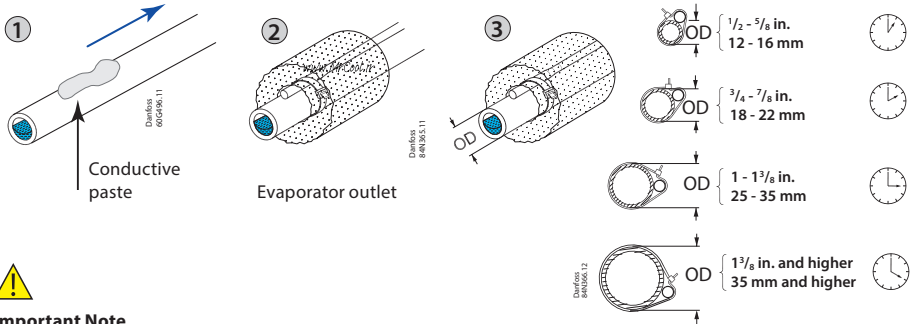

Important Note

- Mount the sensor on a clean paint-free surface.
- Remember to use heat conducting paste and insulate the sensor.
- For precise measurements, mount the sensor max. 5 cm from the outlet of the evaporator.

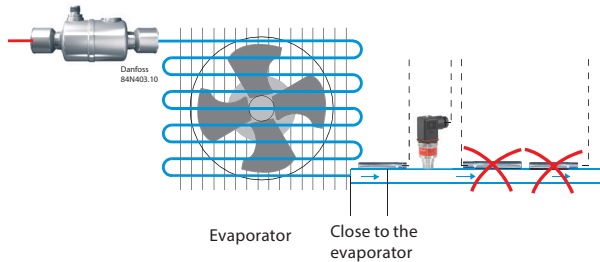

Pressure transmitter

- Installation of the pressure transmitter is less critical. However, the pressure transmitter should be closer to the temperature sensor, right after the evaporator and with its head upright. It is a good practice to select a pressure transmitter with an average load of 40 – 60% of full scale.
- Pressure transmitter values can be shared with multiple EKE 1C via CANbus.

Power supply

- Power sharing is allowed in EKE controller.
- It is a good practice not to reverse the polarity of the power connection cables. Selection of the common power supply depends on the total number of sharings and the valve in use.

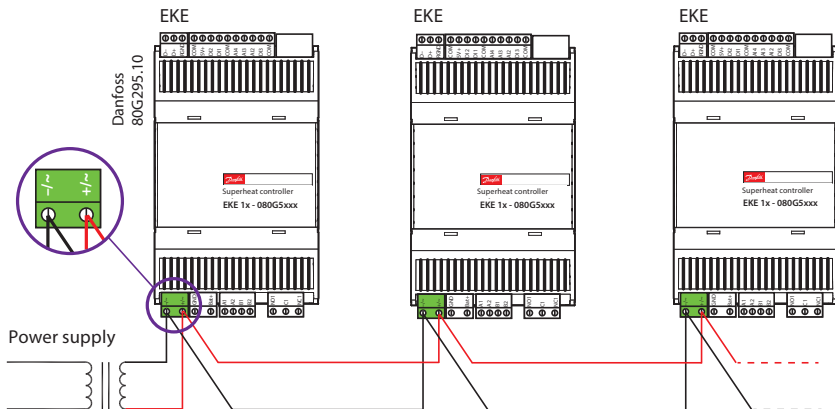

Relay Outputs

EKE 1C has 1 relay output:

- Type SPDT relay. Digital Output can be used to connect either a solenoid valve or an alarm.
- The relays cannot be used for the direct connection of capacitive loads such as LEDs and ON/OFF control of EC motors. All loads with a switch-mode power supply must be connected with a suitable contactor or similar.

Cable length

EKE controller supports the following max. cable length.

	Cable length	Wire size min. / max.
	[m]	[mm ²]
Analog inputs (Voltage)	max. 10	0.14 / 1.5
Temperature sensor	max. 10 *)	-
Stepper valve connection	max. 30	0.14 / 1.5
Power supply	max. 5	0.2 / 2.5
Digital input	max. 10	0.14 / 1.5
Digital output	-	0.2 / 2.5
Digital MMI	max. 3 over CAN RJ	-
Communication bus	max. 1000	0.14 / 1.5

Cable and wiring *)

- The max. cable distance between the controller and the valve depends on many factors like shielded/unshielded cable, the wire size used in the cable, the output power for the controller and EMC.
- Keep controller and sensor wiring well separated from mains wiring.
- Connecting sensors by wires more than the specified length may decrease the accuracy of measured values.



Warning

Separate the sensor and digital input cables as much as possible (at least 10 cm) from the power cables to the loads to avoid possible electromagnetic disturbance. Never lay power cables and probe cables in the same conduits (including those in the electrical panels).

Connecting Modbus

- For the MODbus cable, it is best to use 24 AWG shielded twisted-pair cable with a shunt capacitance of 16 pF/ft and 100Ω impedance.
- The controller provides an insulated RS485 communication interface which is connected to the RS485 terminals (see connection overview).
- The max. permissible number of devices simultaneously connected to RS485 cable output is 32. The RS485 cable is of impedance 120 Ω with maximum length of 1000 m.
- Terminal resistors 120 Ω for terminal devices are recommended at both ends.
- The EKE communication frequency (baud rate) can be one of the following: 9600, 19200 or 38400 baud, default 19200 8 E 1.
- The default unit address is 1, which can be changed using parameter "G001 Controller adr. ".

Modbus

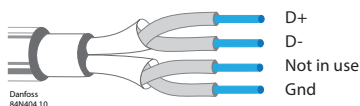

For a detailed explanation of Modbus installation and setting software parameters, see: Data sheet for "EKE Superheat controller" and "EKD EIM Data Communication Modbus RS485 RTU".

Stepper Motor Output

- All valves are driven in a bipolar mode with a 24V supply chopped to control the current (Current driver).
- The stepper motor is connected to the “Stepper Valve” terminals (see terminal assignment) with a standard M12 connection cable.
- To configure stepper motor valves other than Danfoss stepper motor valves, the correct valve parameters must be set as described in the Valve configuration section (see manual for details).
- The default valve setting in EKE 1C is: none.
- The correct valve must be defined in “Valve configuration”, i.e. parameter I067. An overview of valve types is given in the “Parameter identification” section.

Valve Cable Connection

ETS Colibri / KVS Colibri/ ETS / KVS / CCM / CCMT / CTR

Danfoss M12 Cable	White	Black	Red	Green
ETS / KVS / CCM Pins	3	4	1	2
ETS Colibri / KVS Colibri® / CCMT / CTR/ Pins	A1	A2	B1	B2
EKE terminals	A1	A2	B1	B2

Pin designation used in above table are shown in the product data sheet.

ETS 6

Wire color	Orange	Yellow	Red	Black	Gray
EKE terminals	A1	A2	B1	B2	Not connected

Guideline for long M12 cables on Danfoss stepper motor valves

- Long cables will lead to degradation of performance.
- You can overcome this degradation by changing the settings for the valve driver. This guideline is based on the cable type being the same type as the standard Danfoss stepper motor cable.

Recommended wire size and cable distance between EKE controller and stepper motor valve

Cable length	1 m – 15 m	15 m – 30 m	30 m – 50 m
Wire diameter	0.52 / 0.33 mm ² (20 / 22 AWG)	0.33 mm ² (20 AWG)	0.82 mm ² (18 AWG)

Parameter setting for long M12 cable

Product	0 m – 15 m cable	15 m – 30 m cable	30 m – 50 m cable
	Update following parameter		
ETS 12C - ETS 100C KVS 2C - KVS 5C	Use default values	I028 Valve drive current= 925 mA peak	I028 Valve drive current = 1000 mA peak I065 Valve duty cycle = 90%
ETS 12.5 - ETS 400 KVS 15 - KVS 42 CTR 20 CCMT 2 - CCMT 8 CCM 10 - CCMT 40	Use default values	I028 Valve drive current= 200 mA peak	I028 Valve drive current = 300 mA peak
ETS 6	Use default values	I028 Valve drive current= 270 mA peak	I028 Valve drive current = 350 mA peak
CCMT 0	Use default values	I028 Valve drive current= 270 mA peak	I028 Valve drive current = 350 mA peak
CCMT 1	Use default values	I028 Valve drive current= 400 mA peak	I028 Valve drive current= 500 mA peak
CCMT 16 - CCMT 42	Use default values	I028 Valve drive current= 450 mA peak	I028 Valve drive current= 500 mA peak

LED indication

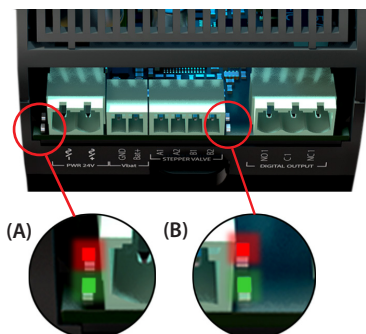

(A) Two status LEDs to indicate operational status

- Steady green = power ON
- Flashing green = data transmission / initialization
- Flashing red = alarm / error condition

(B) Two status LEDs to indicate valve operation

- Flashing red = valve closing
- Steady red = valve fully closed
- Flashing green = valve opening
- Steady green = valve fully open
- Both green and red flashing = valve-related alarm

USER INTERFACE

EKE 1C can be setup using one of the following user interfaces:

1. Danfoss KoolProg software
2. Danfoss MMIGRS external display.
3. Communication bus: Modbus RS485 RTU

KoolProg

KoolProg is a software tool for quickly and easily configuring EKE controllers. It enables you to make online changes to parameter configuration, copy settings to multiple controllers, monitor the live status of input / outputs, and quickly analyze controller behavior and program patterns with a graphical trending tool.

KoolProg Software is available for download free of charge at <http://koolprog.danfoss.com>.

KoolProg requires a Gateway (code 080G9711) to connect to the PC.

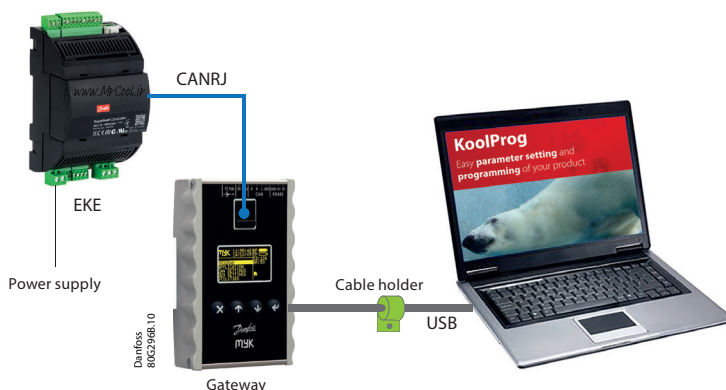

Important note!

To guarantee a reliable USB connection to a host device (e.g. industrial PC), you must:

- Connect terminals R and H on MMIMYK CAN port using a termination wire.
- Place cable holder close to MMIMYK to keep USB connector firmly in place.
- Keep USB cable length < 1 m.
- Place MMIMYK and route USB cable far from noise sources (inverter, motors, contactors etc.)

Danfoss MMIGRS2 display

Connecting external MMIGRS2 display

MMIGRS2 display can be used to set up EKE 1C. The display can be used not only for setting up the necessary parameters, but also as an external display during operation to show important parameters, e.g. degree of opening of valve, superheat, etc.

Important note:

- Max. distance between controller and display is 3 m over CAN RJ.
- CANbus requires termination in both ends of the cable by a 120 Ohm resistor to ensure reliable communication.
- On EKE 1C and MMI, the termination must be included by shorting CAN R and CAN H with a wire.
- No external power supply for MMIGRS2 is needed while using CAN RJ connector.

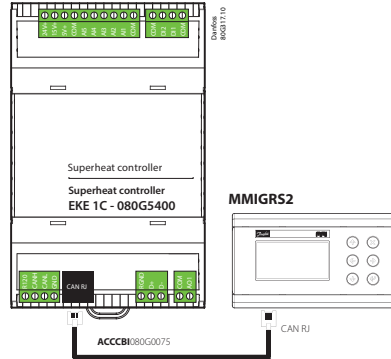

MMIGRS2 (Back view)

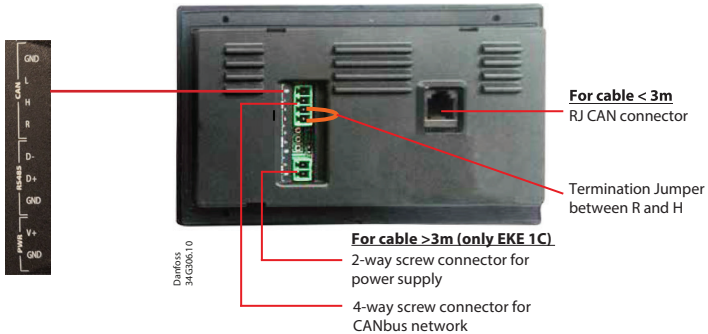

MMIGRS2 (Front view)

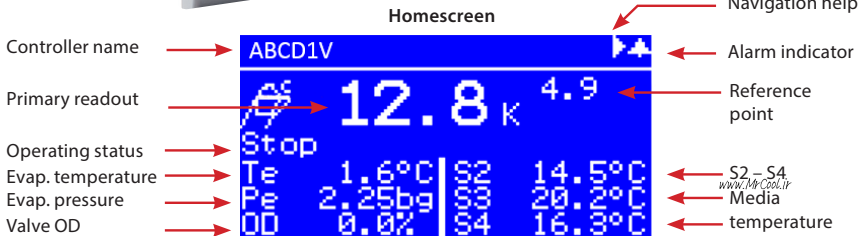

Note: Setup and service menu requires login with the default password 100 (daily use), 200 (service use) or 300 (commissioning use). Long press Enter key to access login menu.

Setup wizard via MMIGRS2 display

When all connections to the controller have been made, after the power is switched on, the Danfoss logo will appear for 5 seconds, then the Home screen will be displayed.

To access the Wizard: press and hold enter to access the Login screen, the commissioning password is 300, scroll down the Setup and service menu and select "Setup wizard".

The Wizard workflow is: a. Language selection; b. Application selection; c. Input configuration; and d. Output configuration.

When using the Setup Wizard, repeat the following sequence for all parameter settings:

- a. From **Setup wizard**, select relevant parameters.
- b. Press ENTER to highlight 1st option
- c. Scroll with UP / DOWN to your desired option
- d. If the selected default value is acceptable, press DOWN to get to the next settings. Otherwise, press ENTER to set your choice
- e. Scroll with DOWN to the next parameter (repeat sequence a. to e.)

Note:

- If you do not have sufficient information to complete the Wizard, leave settings on their default values. To generate the requested info, you can use Danfoss Coolselector2 software to calculate operating conditions and valve OD for the same operating point.
- Setup Wizard only covers the most important parameters. If other features are to be enabled (e.g. Alarm settings, MOP/LOP, etc.), they must be configured separately once the Setup Wizard is done.

Setup Wizard is also available in KoolProg PC tool.

The workflow process is the same as that described above for MMIGRS2 display.

For details, please refer to EKE data sheet.

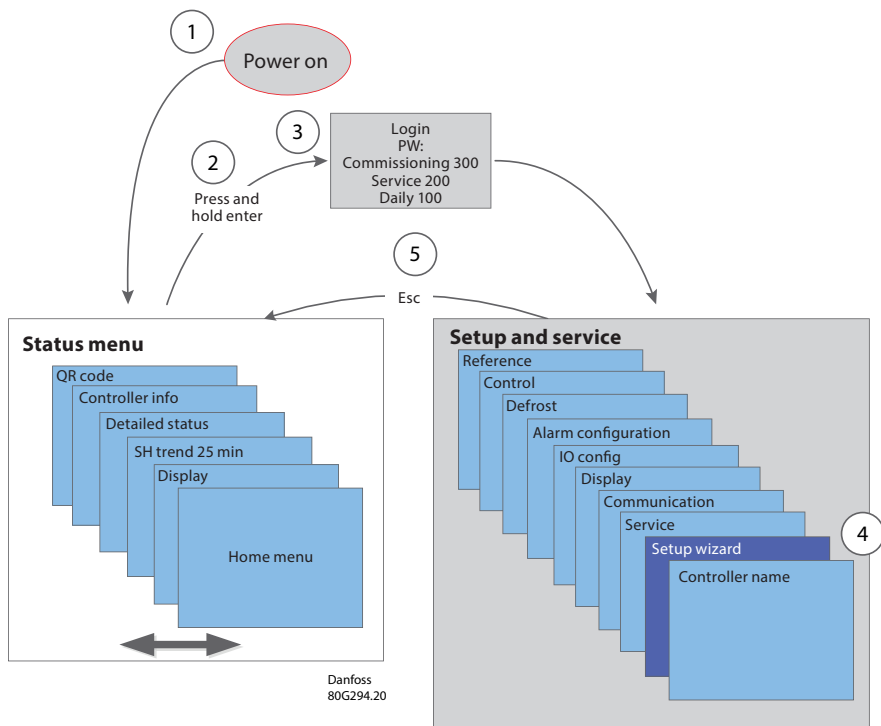

Quick guide for parameter selection

Apart from wizard setup, users can also use the following section which describes quick parameter settings for general applications.

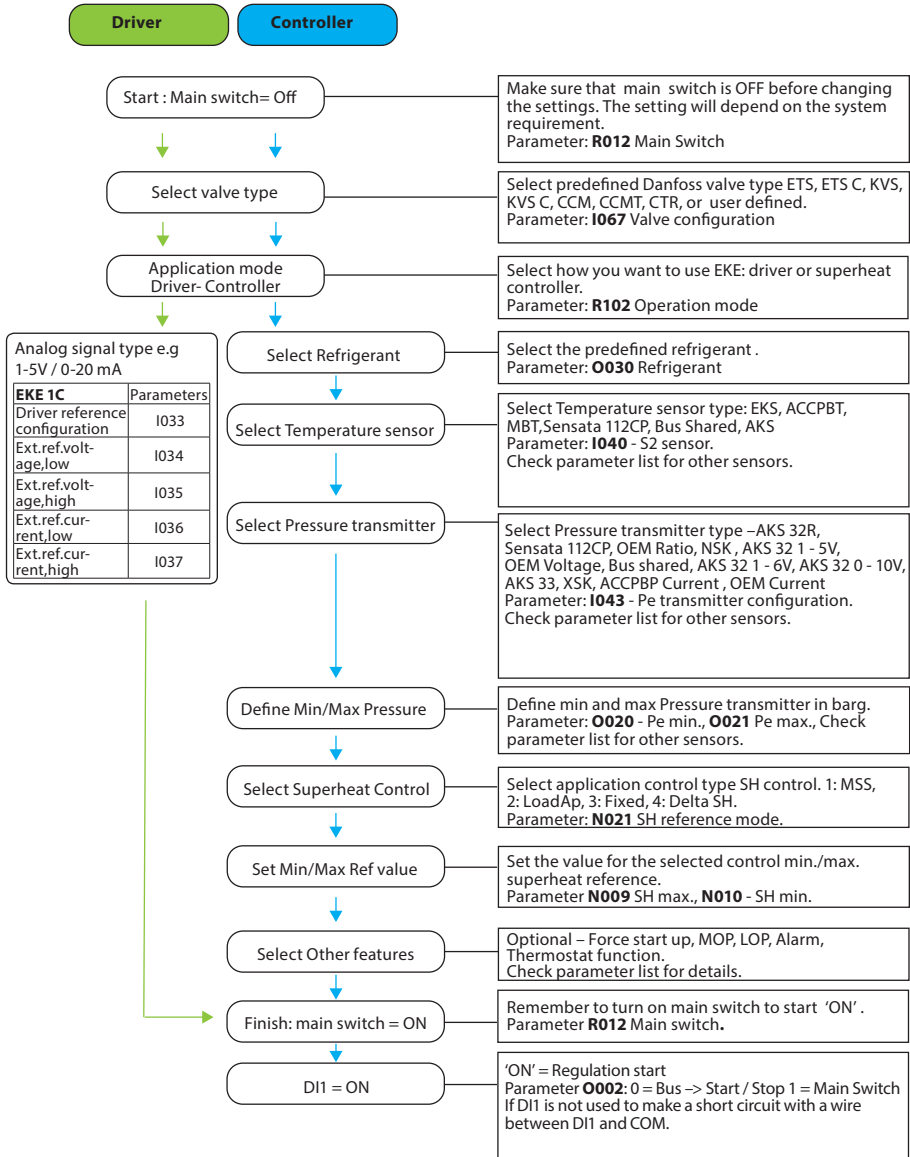

EKE 1C – Commonly used parameter identification

PNU - equivalent to the Modbus register no. (Modbus address +1).

Actual value are read/written as 16-bit integer values without decimals. This is the default value as read via Modbus.

Parameter	PNU	Default	Description
R012 Main switch	3001	0	0 = regulation Off 1 = regulation On
R102 Operation mode	3002	0	0 = Superheat control 1 = Valve driver
O002 DI1 configuration	3101	1	0 = Bus→Start/Stop 1 = Main Switch
I033 Driver reference configuration	3131	0	0 = Voltage to OD 1 = Modbus to OD 2 = Modbus to steps 3 = Current to OD
I034 Ext ref. voltage low	3130	0	Range 0 – 10 V. To be used with I033
I035 Ext ref. voltage high	3129	10	Range 0 – 10 V. To be used with I033
I036 Ext ref. current low	3128	4	Range 0 – 20 mA. To be used with I033
I037 Ext ref. current high	3127	20	Range 4 – 20 mA. To be used with I033
I067 Valve configuration	3132	0	0 = no valve, 1 = UserDef 2 = ETS 12C, 3 = ETS 24C, 4 = ETS 25C, 5 = ETS 50C, 6 = ETC 100C 7 = ETS 6, 8 = ETS 12.5, 9 = ETS 25, 10 = ETS 50, 11 = ETS 100, 12 = ETS 250, 13 = ETS 400 14 = KVS 2C, 15 = KVS 3C, 16 = KVS 5C 17 = KVS 15, 18 = KVS 42 19 = CCMT 0, 20 = CCMT 1 21 = CCMT 2, 22 = CCMT 4, 23 = CCMT 8, 24 = CCMT 16, 25 = CCMT 24, 26 = CCMT 30, 27 = CCMT 42 28 = CCM 10, 29 = CCM 20, 30 = CCM 30, 31 = CCM 40 32 = CTR 20
O030 Refrigerant	3017	0	0 = Undef 10 = R503 20 = R407C 30 = R417A 40 = 448A 1 = R12 11 = R114 21 = R407A 31 = R422A 41 = 449A 2 = R22 12 = R142b 22 = R407B 32 = R413A 42 = 452A 3 = R134A 13 = R User 23 = R410A 33 = R422D 43 = R450A 4 = R502 14 = R32 24 = R170 34 = 427A 44 = R452B 5 = R717 15 = R227 25 = R290 35 = R438A 45 = R454B 6 = R13 16 = R401A 26 = R600 36 = R513A 46 = R1233zdE 7 = R13b1 17 = R507 27 = R600a 37 = R407F 47 = R1234zeZ 8 = R23 18 = R402A 28 = R744 38 = R1234ze 48 = R449B 9 = R500 19 = R404A 29 = R1270 39 = R1234yf 49 = R407H
I040 S2 sensor configuration	3105	0	0 = Not defined 1 = EKS 221 2 = ACCPBT NTC10K 3 = MBT 153 10K 4 = 112CP 5 = Bus Shared 6 = AKS
I041 S3 sensor configuration	3106	0	0 = Not defined 1 = EKS 221 2 = ACCPBT NTC10K 3 = MBT 153 10K 4 = 112CP 5 = Bus Shared 6 = AKS
I042 S4 sensor configuration	3107	0	0 = Not defined 1 = EKS 221 2 = ACCPBT NTC10K 3 = MBT 153 10K 4 = 112CP 5 = Bus Shared 6 = AKS
I043 Pe transmitter configuration	3108	0	0 = Not defined 1 = AKS 32R 2 = ACCPBP Ratio 3 = 112CP 4 = OEM Ratio 5 = NSK 6 = AKS 32 1 - 5V 7 = OEM Voltage 8 = Bus shared 9 = AKS 32 1 - 6V 10 = AKS 32 0 - 10V 11 = AKS 33 12 = XSK 13 = ACCPBP Current 14 = OEM Current
O020 Pe transmitter min. (in bar g)	3115	-1	Define pressure range in bar gauge
O021 Pe transmitter max. (in bar g)	3116	12	Define pressure range in bar gauge
I044 Pc transmitter setup	3117	0	0 = Not defined 1 = AKS 32R 2 = ACCPBP Ratio 3 = 112CP 4 = OEM Ratio 5 = NSK 6 = AKS 32 1 - 5V 7 = OEM Voltage 8 = Bus shared 9 = AKS 32 1 - 6V 10 = AKS 32 0 - 10V 11 = AKS 33 12 = XSK 13 = ACCPBP Current 14 = OEM Current
O047 Pc transmitter min. (in bar g)	3124	-1	Define pressure range in bar gauge
O048 Pc transmitter max. (in bar g)	3125	34	Define pressure range in bar gauge
N021 SH reference mode	3027	2	0 = Fixed SH 1 = Loadap 2 = MSS 3 = Delta temp
N107 SH fixed setpoint (K)	3028	7	Range 2 K – 40 K
N009 SH max. (K)	3029	9	Range 4 K – 40 K
N010 SH min. (K)	3030	4	Range 2 K – 9 K
N116 SH ref. delta temp. factor (%)	3035	65	Range 20 – 100

For a detailed parameter list and explanation, please check the EKE data sheet.

Related products

MMIGRS2 Display	Power Supply	MMIMYK Gateway
		
<p>User interface module MMIGRS2 Display</p>	<p>AK-PS Input: 100 – 240 V AC, 45 – 65 Hz Output: 24 V DC: available with 18 VA, 36 VA and 60 VA</p> <p>ACCTRD Input: 230 V AC, 50 – 60 Hz Output: 24 V AC, available with 12 VA, 22 VA and 35 VA</p>	<p>MMIMYK device is used as a gateway to connect EKEs and the PC tool i.e KoolProg software for parameter setting or data logging.</p>
Pressure Transducer	Temperature Sensor	
		
<p>AKS Pressure Transducer Available with ratiometric and 4 – 20 mA.</p> <p>NSK Ratiometric pressure probe</p> <p>XSK Pressure probe 4 – 20 mA</p>	<p>PT 1000 AKS is a High precision temp. sensor AKS 11 (preferred), AKS 12, AKS 21 ACCPBT PT1000</p> <p>NTC sensors EKS 221 (NTC-10 Kohm) MBT 153 ACCPBT NTC Temp probe (IP 67 /68)</p>	
ACCCBI Cable	Stepper motor valves	M12 cable
		
<p>ACCCBI cables for MMI display and gateway.</p>	<p>EKE is compatible with Danfoss stepper motor valves i.e Danfoss ETS 6, ETS, KVS, ETS Colibri®, KVS colibri®, CTR, CCMT</p>	<p>M12 Angle cable to connect Danfoss stepper motor valve and EKE controller</p>